

**TECHNICAL DATA SHEETS**

*Closed Impeller 750  
Pump Curve Booklet*



## TECHNICAL SPECIFICATIONS



### ISP Process Pumps - ISP100-400 (125-100-400) ISP Impeller 283917 CLOSED B13 Z5

#### Performance Curve - ISP100-400-C-710

710 rpm

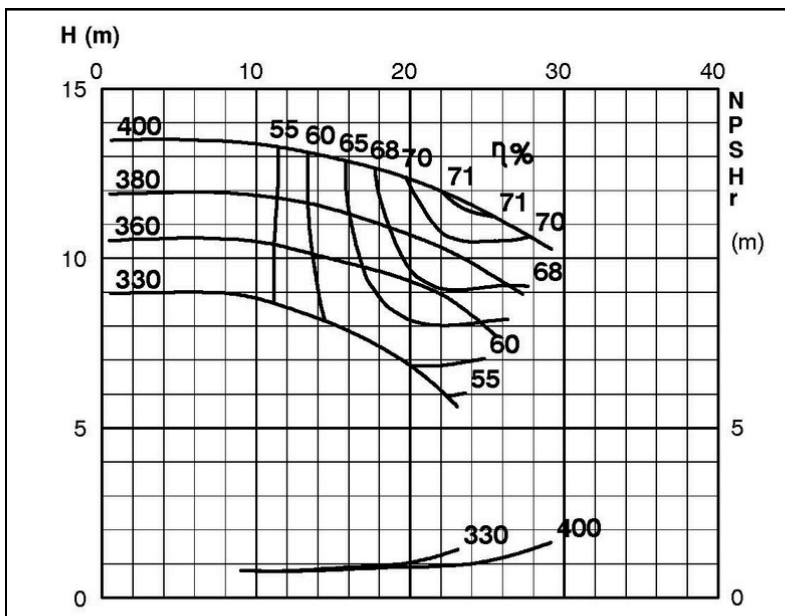

IMPELLER DIA	
∅d <sub>2</sub> (mm)	∅d <sub>b</sub> (mm)
400	303
395	299
390	295
385	292
380	289
375	287
370	284
365	282
360	279
355	277
350	275
345	273
340	270
335	269
330	267

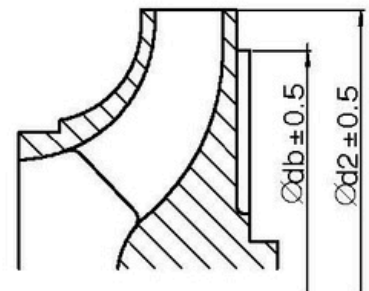
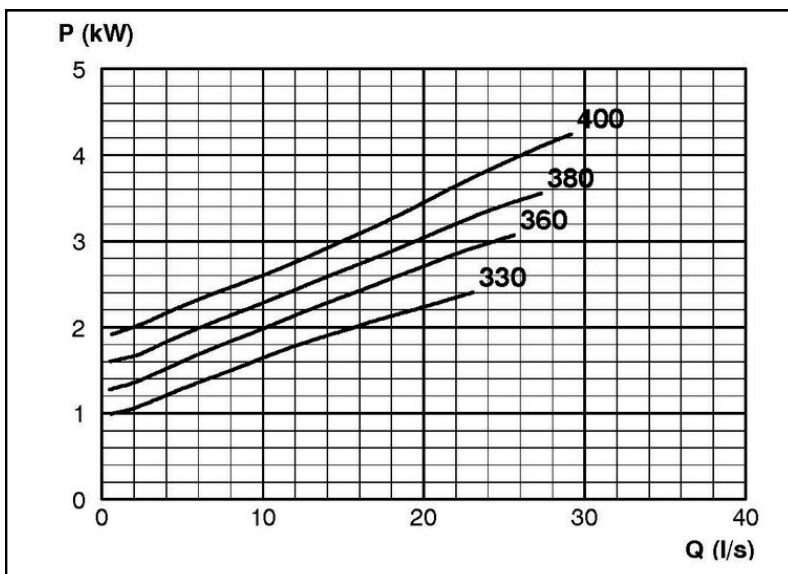

RET4144

## TECHNICAL SPECIFICATIONS

### ISP Process Pumps - ISP125-400 (150-125-400) ISP Impeller 283918 CLOSED B22 Z6

#### Performance Curve - ISP125-400-C-720

720 rpm

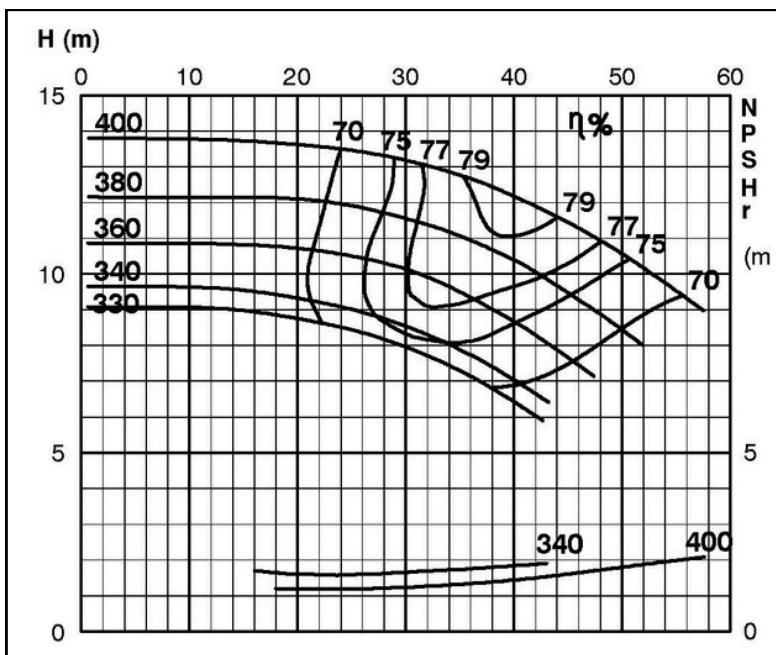

IMPELLER DIA			
Ød <sub>2</sub> (mm)	K°	Ød <sub>a</sub> (mm)	Ød <sub>b</sub> (mm)
400			331
395			327
390			323
385			320
380	1	379	316
375	2	373	314
370	2	369	311
365	3	363	308
360	3	358	305
355	4	352	303
350	4	347	301
345	5	341	298
340	6	335	295
335	7	329	293
330	8	323	290

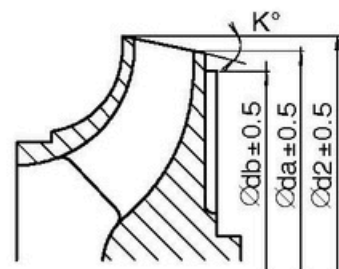
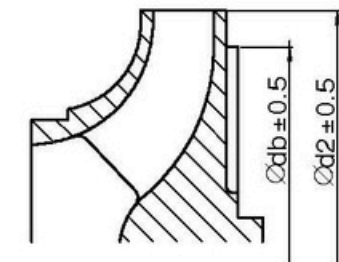
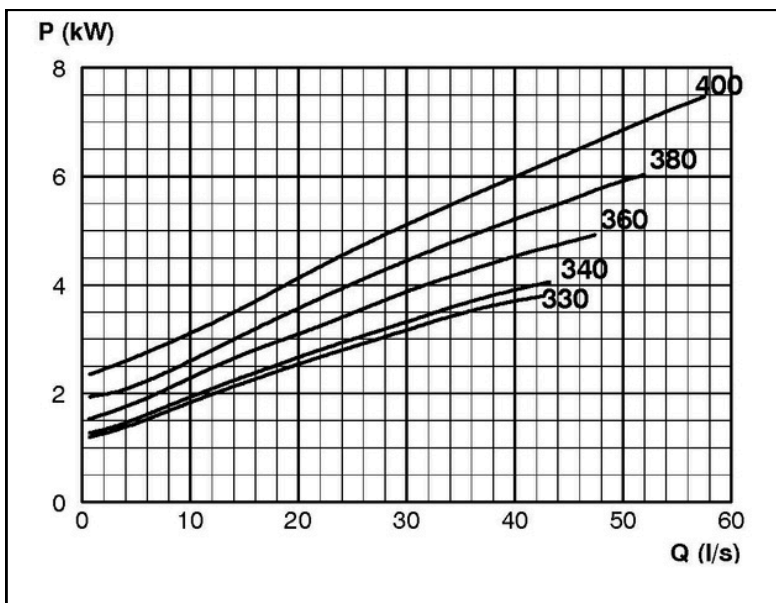

RET14146

## TECHNICAL SPECIFICATIONS



### ISP Process Pumps - ISP250-315 (300-250-315) ISP Impeller 283923 CLOSED B64 Z6

#### Performance Curve - ISP250-315-C-730

730 rpm

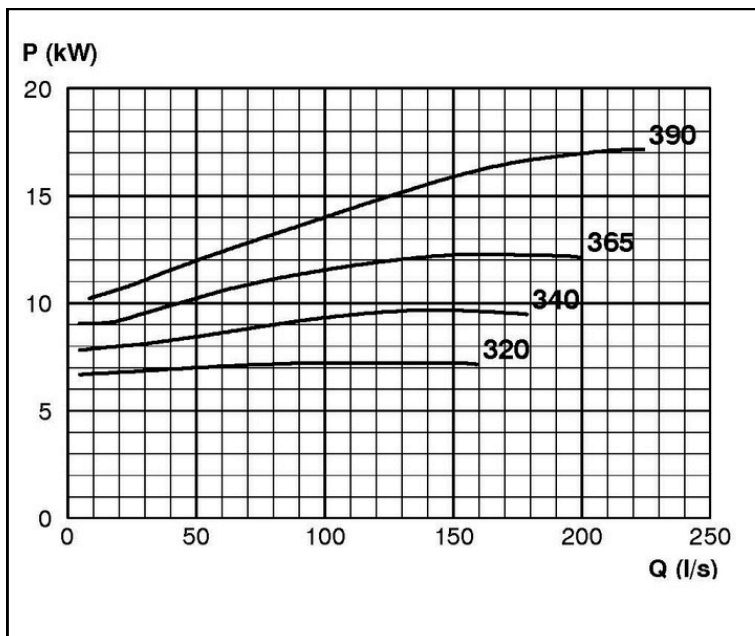
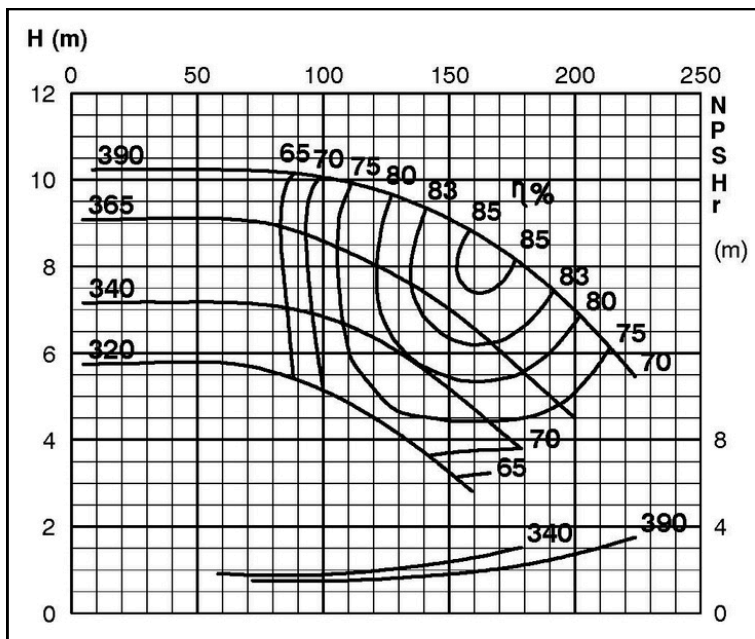

IMPELLER DIA			
Ød <sub>2</sub> (mm)	K°	Ød <sub>a</sub> (mm)	Ød <sub>b</sub> (mm)
390	9	370	365.6
385	9	365	
380	10	357	
375	10	352	
370	11	344	
365	11	339	
360	12	331	
355	13	324	
350	14	316	
345	15	308	
340	16	300	
335	17	291	
330	18	283	
325	19	275	
320	20	266	

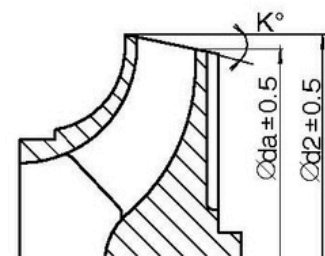
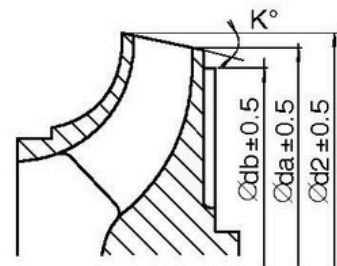

RET14147

## TECHNICAL SPECIFICATIONS



### ISP Process Pumps - ISP300-315 (350-300-315) ISP Impeller 283924 CLOSED B72 Z6

#### Performance Curve - ISP300-315-C-730

730 rpm

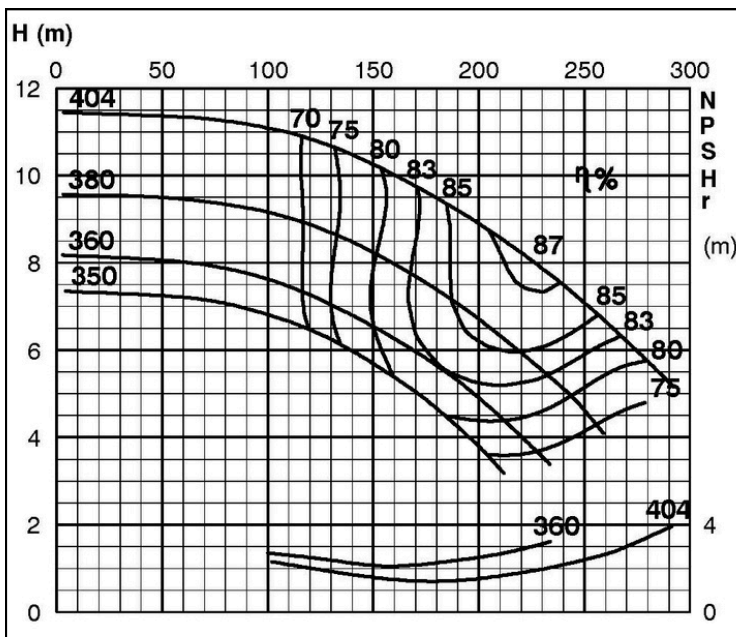

IMPELLER DIA			
$\varnothing d_2$ (mm)	$K^\circ$	$\varnothing d_a$ (mm)	$\varnothing d_b$ (mm)
404	13	371.6	365.5
400	13	367.0	365.5
395	14	359.0	
390	14	354.0	
385	15	346.0	
380	16	338.0	
375	17	330.0	
370	18	322.0	
365	19	314.0	
360	20	305.0	
355	22	294.0	
350	24	282.0	

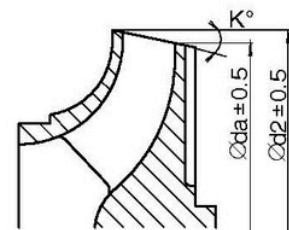
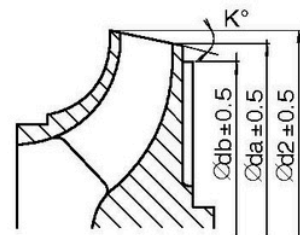
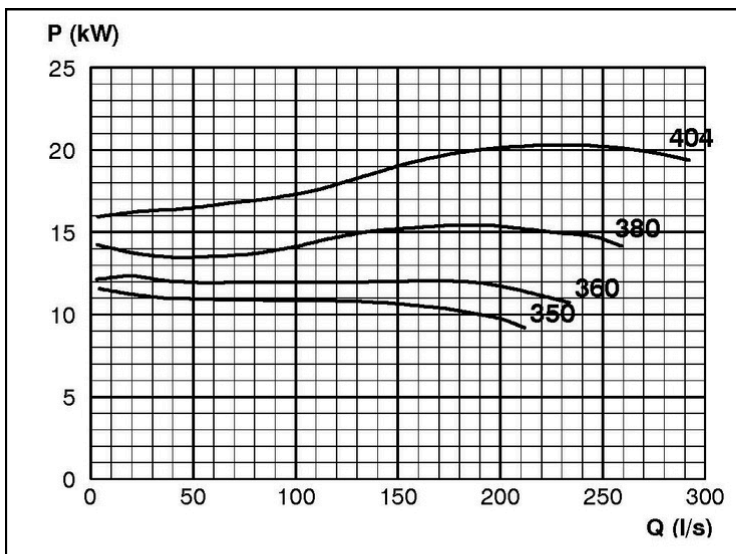

RET14148

## TECHNICAL SPECIFICATIONS



### ISP Process Pumps - ISP150-400 (200-150-400) ISP Impeller 283925 CLOSED B26 Z6

#### Performance Curve - ISP150-400-C-730

730 rpm

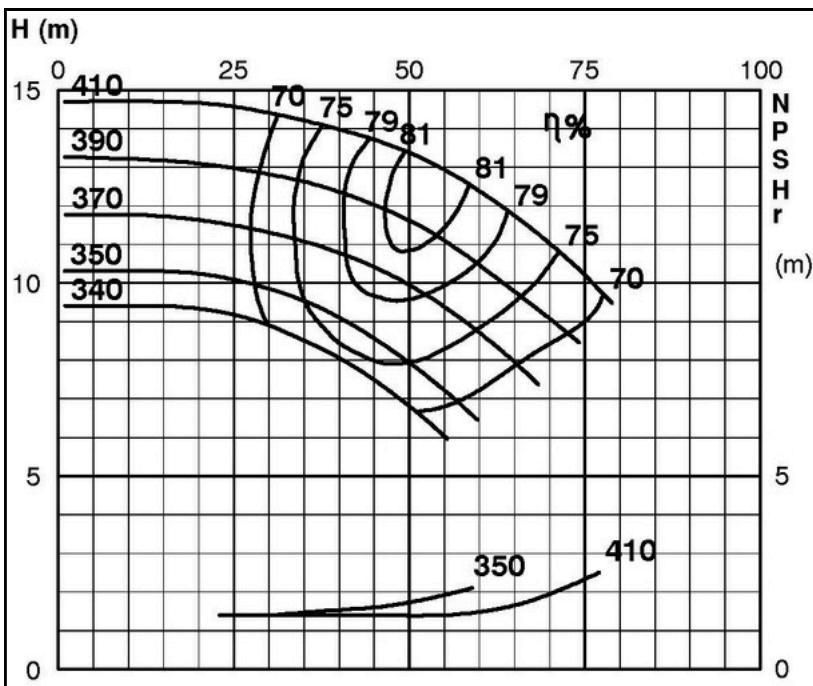

IMPELLER DIA			
Ød <sub>2</sub> (mm)	K°	Ød <sub>a</sub> (mm)	Ød <sub>b</sub> (mm)
410			358
405			354
400			350
395			346
390			342
385			340
380	1	379	337
375	2	373	335
370	3	367	332
365	4	361	329
360	5	355	325
355	6	349	323
350	7	343	320
345	7	338	316
340	8	332	311

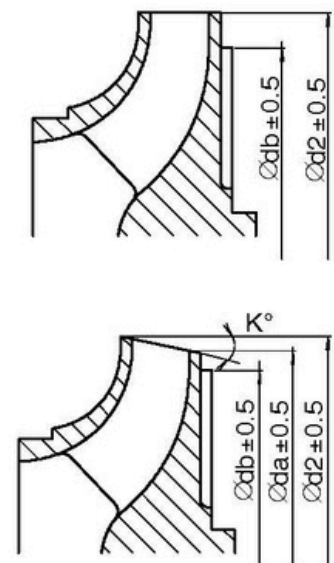
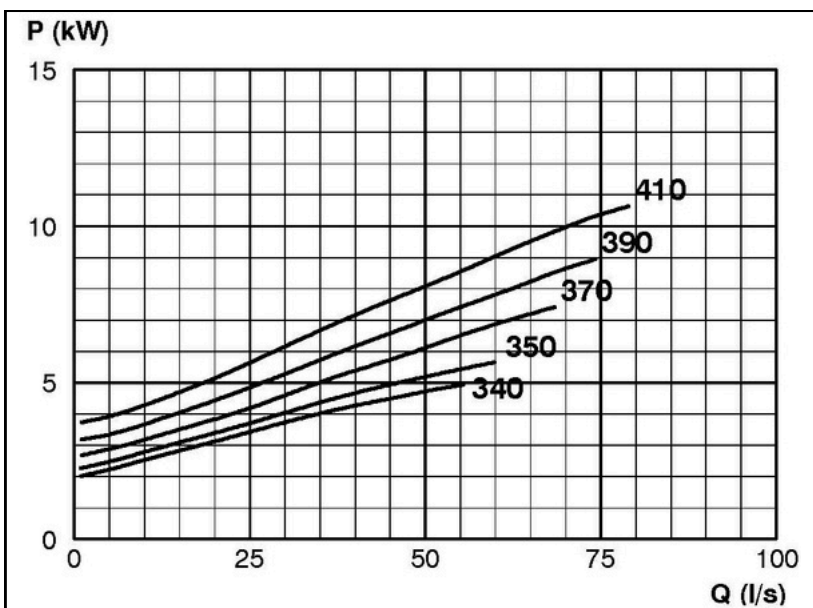

RET14149

## TECHNICAL SPECIFICATIONS



### ISP Process Pumps - ISP200-400 (250-200-400) ISP Impeller 283926 CLOSED B41 Z6

#### Performance Curve - ISP200-400-C-730

730 rpm

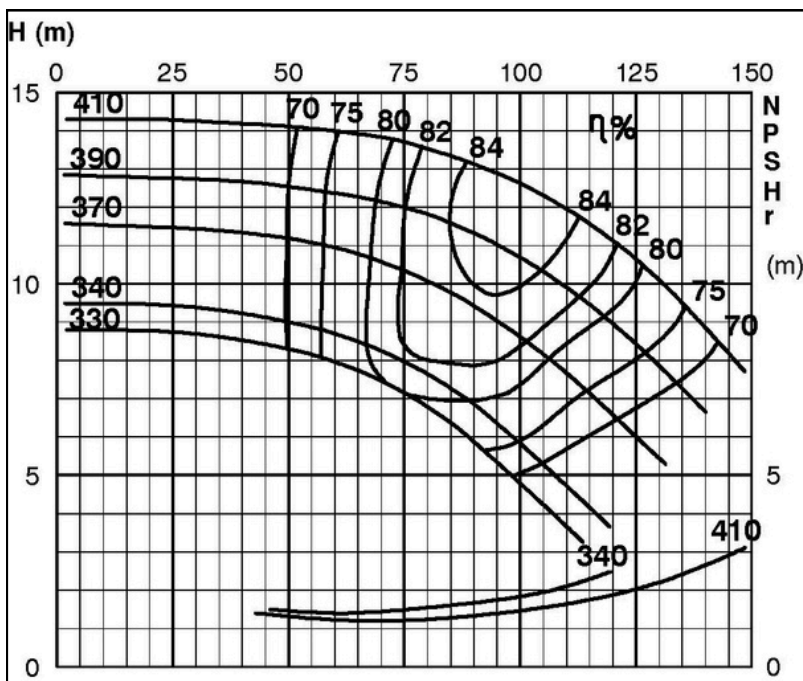

IMPELLER DIA			
$\varnothing d_2$ (mm)	$K^\circ$	$\varnothing d_a$ (mm)	$\varnothing d_b$ (mm)
410			399
405			396
400			392
395			389
390			385
385			382
380			378
375			
370			
365			
360			
355	1	354.0	
350	2	347.0	
345	3	340.0	
340	4	334.0	
335	5	327.0	
330	6	320.0	

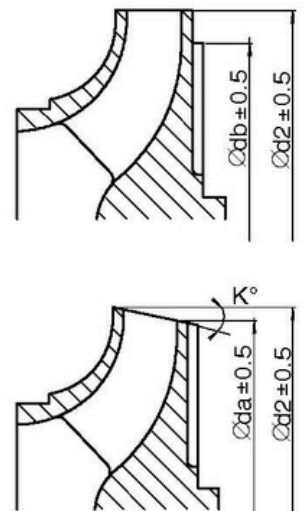
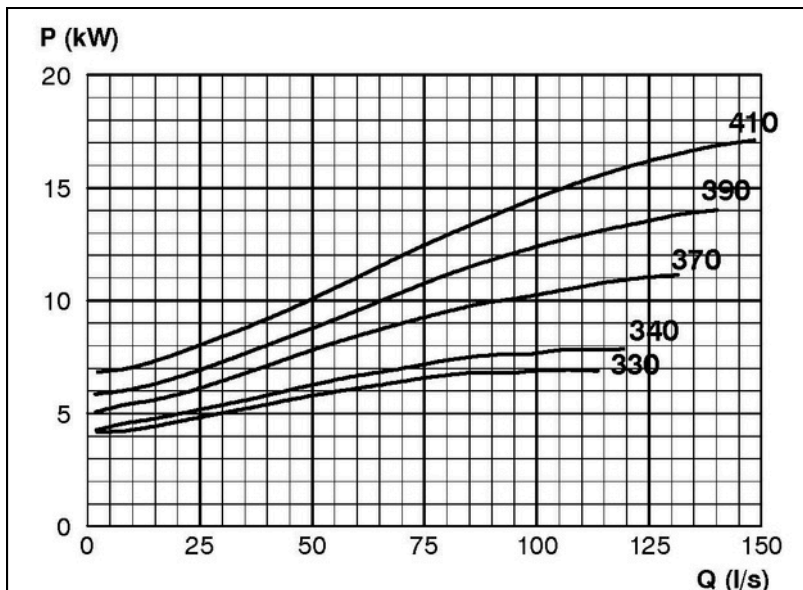

RET14150

## TECHNICAL SPECIFICATIONS



### ISP Process Pumps - ISP250-400 (300-250-400) ISP Impeller 283927 CLOSED B55 Z6

#### Performance Curve - ISP250-400-C-730

730 rpm

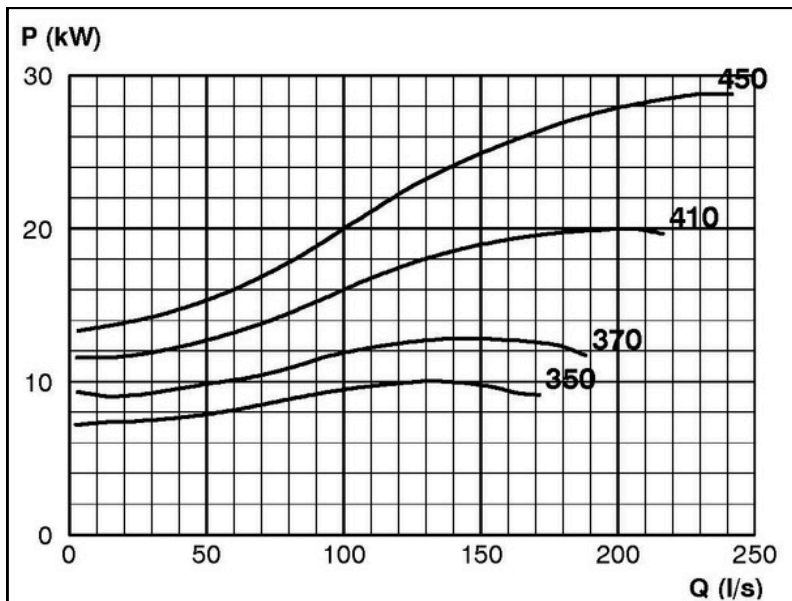
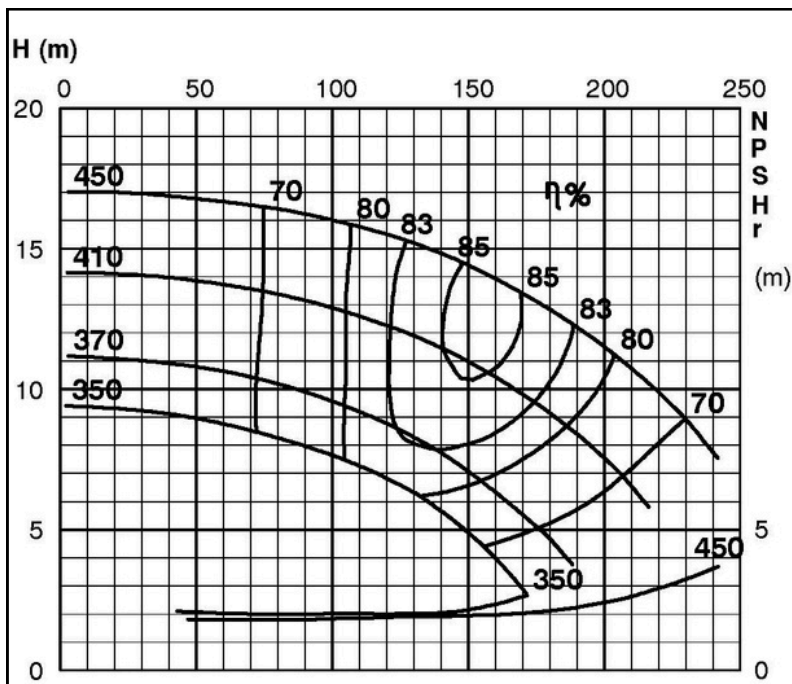

IMPELLER DIA			
Ød <sub>2</sub> (mm)	K°	Ød <sub>a</sub> (mm)	Ød <sub>b</sub> (mm)
450			442
445			440
440			437
435			434
430			
425			
420			
415			
410			
405			
400			
395			
390	2	386	
385	2	381	
380	3	374	
375	4	367	
370	5	359	
365	6	352	
360	7	345	
355	8	337	
350	9	330	

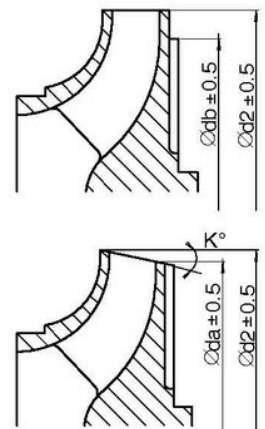

RET14151

## TECHNICAL SPECIFICATIONS



### ISP Process Pumps - ISP300-400 (350-300-400) ISP Impeller 283928 CLOSED B69 Z7

#### Performance Curve - ISP300-400-C-740

740 rpm

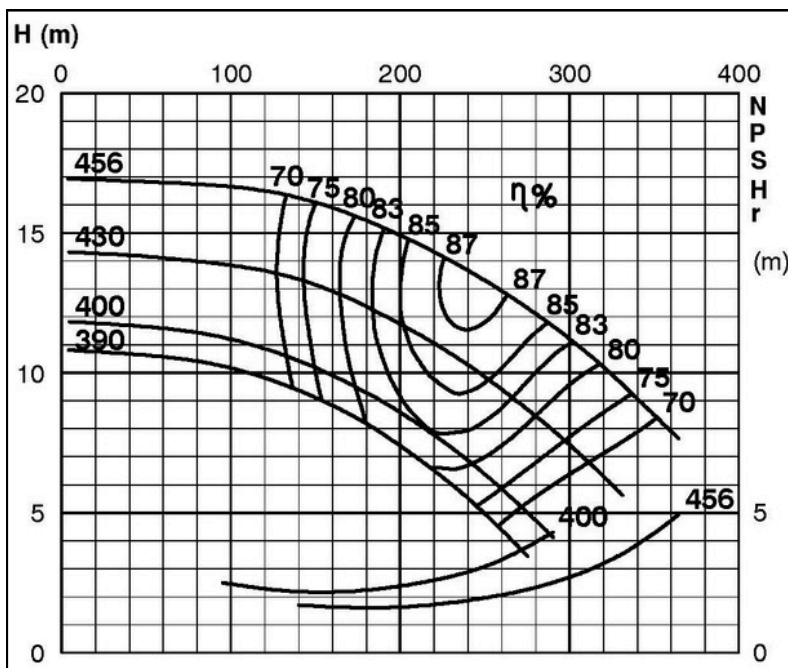

IMPELLER DIA			
∅d <sub>2</sub> (mm)	K°	∅d <sub>a</sub> (mm)	∅d <sub>b</sub> (mm)
456	8	436.9	433.4
450	8	431.0	
445	9	423.0	
440	10	416.0	
435	10	410.0	
430	11	403.0	
425	11	397.0	
420	12	389.0	
415	12	384.0	
410	13	376.0	
405	14	368.0	
400	15	360.0	
395	16	352.0	
390	17	343.0	

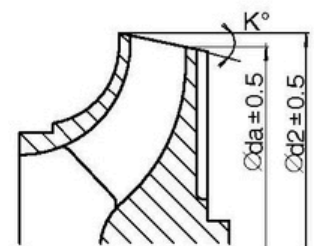
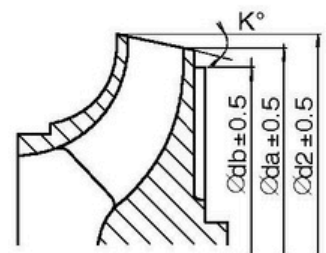
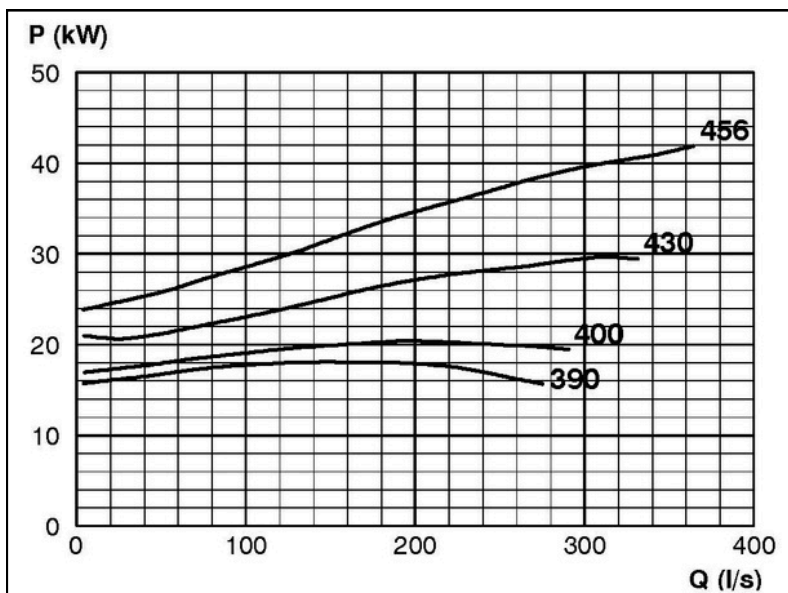

RET14152

## TECHNICAL SPECIFICATIONS



ISP Process Pumps - ISP350-500 (400-350-500)  
ISP Impeller 283929 CLOSED B85 Z6

Performance Curve - ISP350-500-C-740

740 rpm

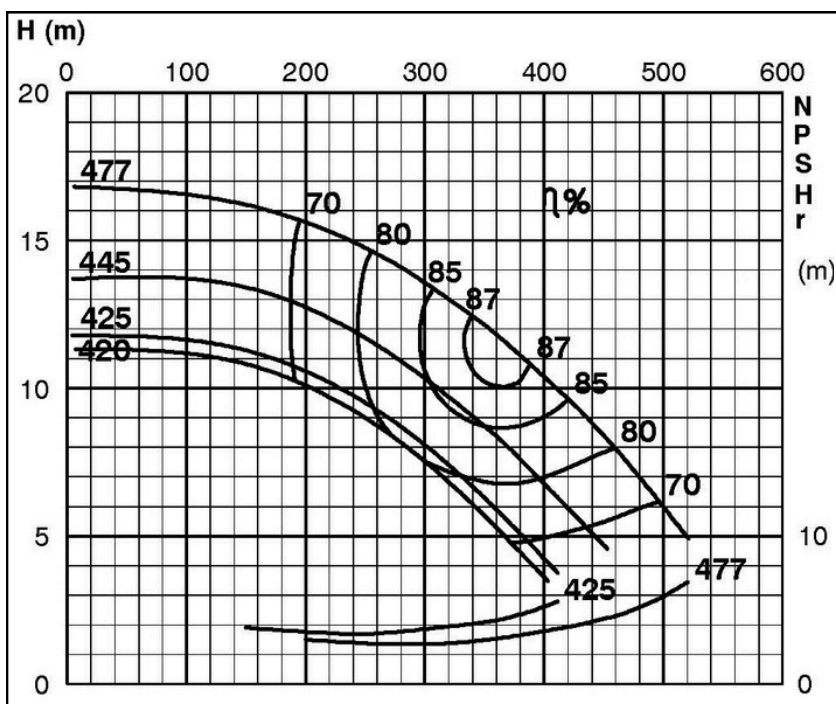

IMPELLER DIA			
Ød <sub>2</sub> (mm)	K°	Ød <sub>a</sub> (mm)	Ød <sub>b</sub> (mm)
477	13	439	432.4
475	13	436	432.4
470	13	431	
465	13	426	
460	13	421	
455	14	412	
450	14	407	
445	15	398	
440	16	389	
435	17	380	
430	18	371	
425	19	362	
420	20	353	

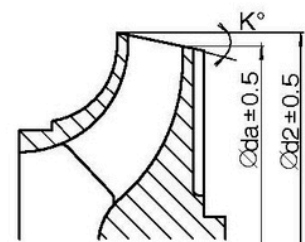
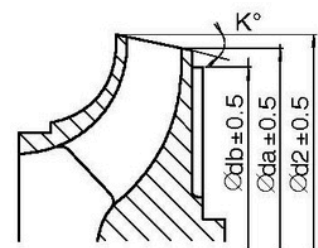
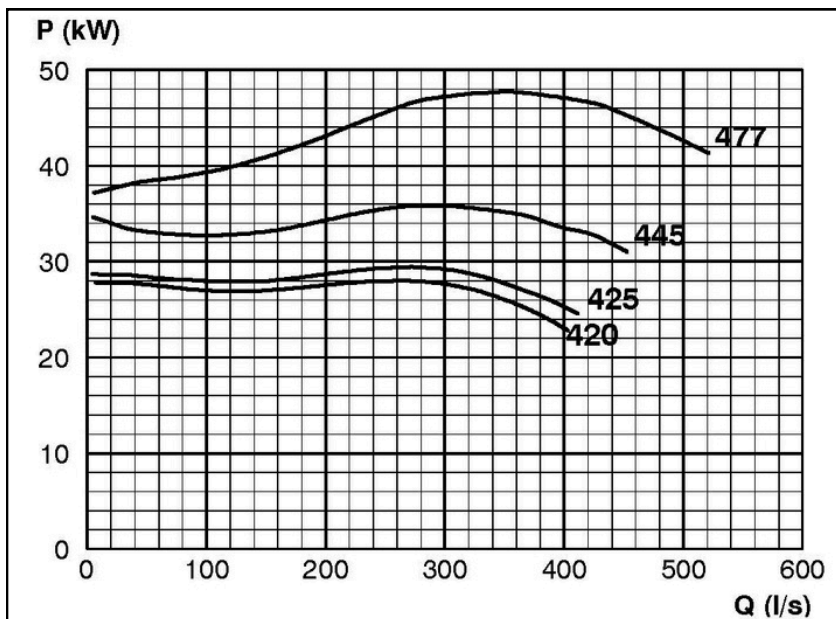

RET14153

## TECHNICAL SPECIFICATIONS



### ISP Process Pumps - ISP400-500 (ISP400-500) ISP Impeller 283929 CLOSED B95 Z6

#### Performance Curve - ISP400-500-C-740

740 rpm

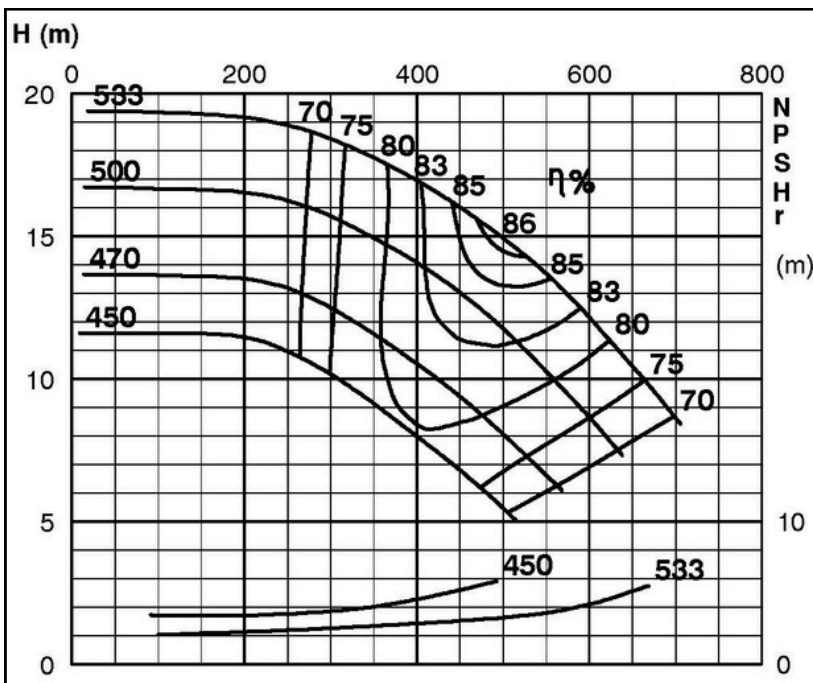

IMPELLER DIA			
∅d <sub>2</sub> (mm)	K°	∅d <sub>a</sub> (mm)	∅d <sub>b</sub> (mm)
533	13	490.5	483
530	13	485.5	483
525	13	482.1	
520	13	476.6	
515	13	471.4	
510	13	465.9	
505	13	460.4	
500	13	454.7	
495	14	445.6	
490	14	439.9	
485	15	430.9	
480	15	425.1	
475	16	415.6	
470	17	406.1	
465	18	396.0	
460	19	386.0	
455	21	375.0	
450	22	362.0	

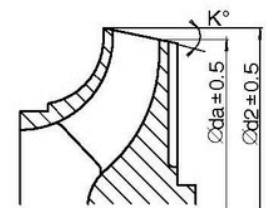
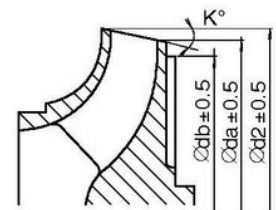
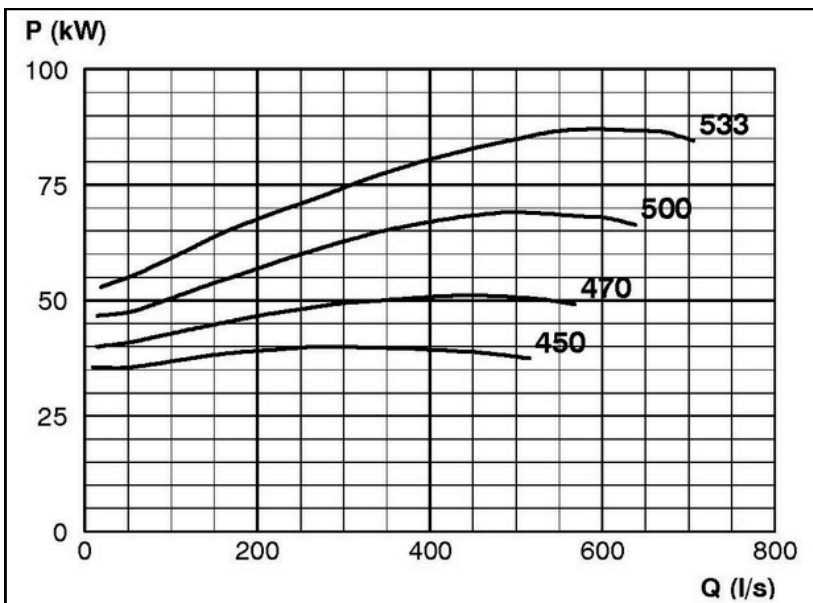

RET14154

## TECHNICAL SPECIFICATIONS



### ISP Process Pumps - ISP100-500 (200-100-500) ISP Impeller 285943 CLOSED B17.5 Z5

#### Performance Curve - ISP100-500-C-730

730 rpm

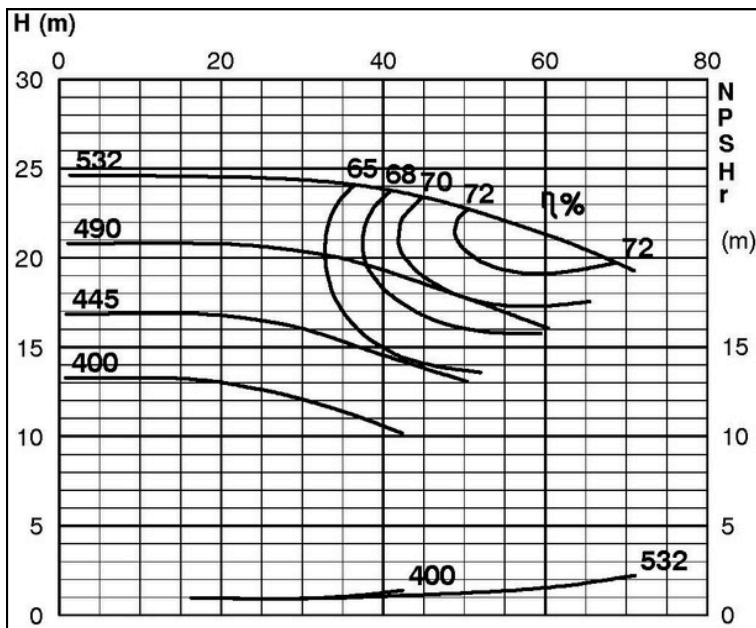

IMPELLER DIA	
$\varnothing d_2$ (mm)	$\varnothing d_b$ (mm)
532	371
525	367
520	365
515	362
510	360
505	357
500	355
495	352
490	350
485	347
480	345
475	342
470	340
465	338
460	336
455	334
450	332
445	330
440	328
435	327
430	326
425	325
420	324
415	323
410	322
405	321
400	320

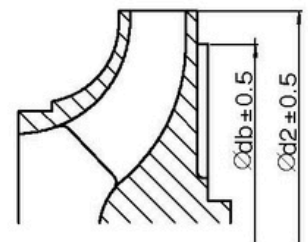
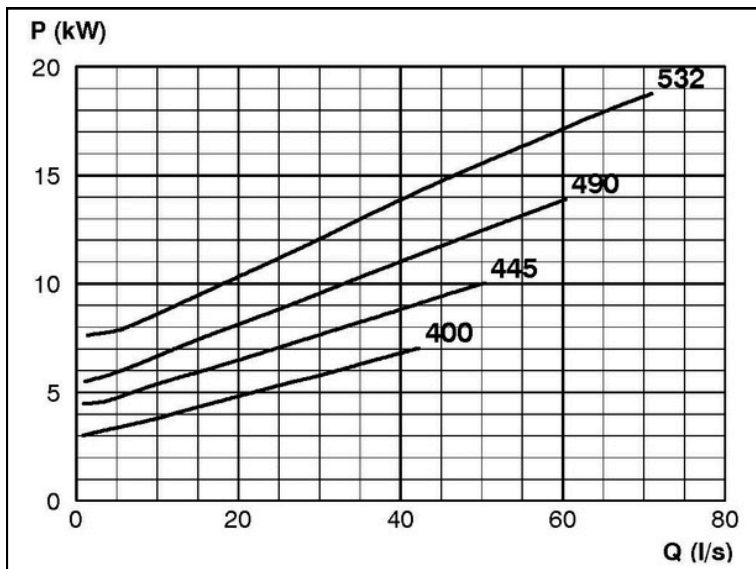

RET14155

## TECHNICAL SPECIFICATIONS



### ISP Process Pumps - ISP150-500 (250-150-500) ISP Impeller 283931 CLOSED B30 Z6

#### Performance Curve - ISP150-500-C-730

730 rpm

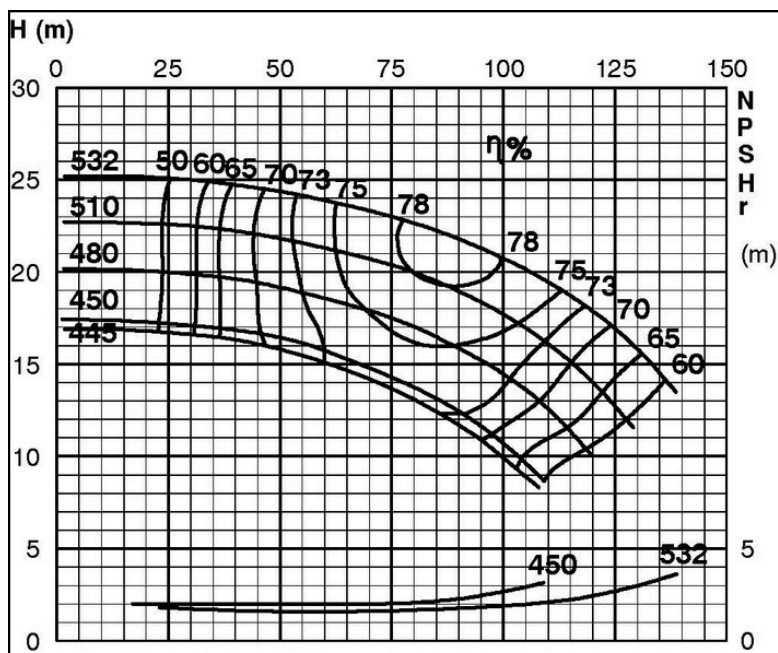

IMPELLER DIA	
∅d <sub>2</sub> (mm)	∅d <sub>b</sub> (mm)
532	459
525	455
520	451
515	447
510	443
505	441
500	438
495	435
490	432
485	430
480	428
475	426
470	424
465	422
460	419
455	417
450	414
445	411

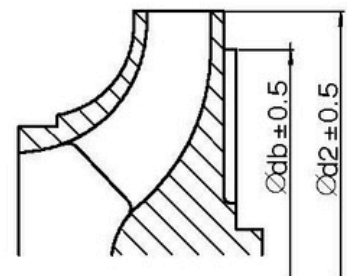
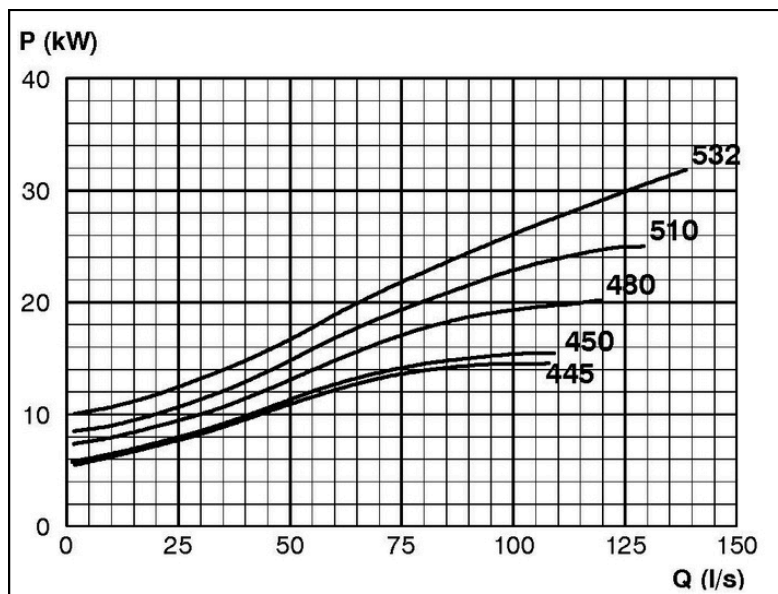

RET14156

## TECHNICAL SPECIFICATIONS



### ISP Process Pumps - ISP200-500 (250-200-500) ISP Impeller 283932 CLOSED B35 Z6

#### Performance Curve - ISP200-500-C-740

740 rpm

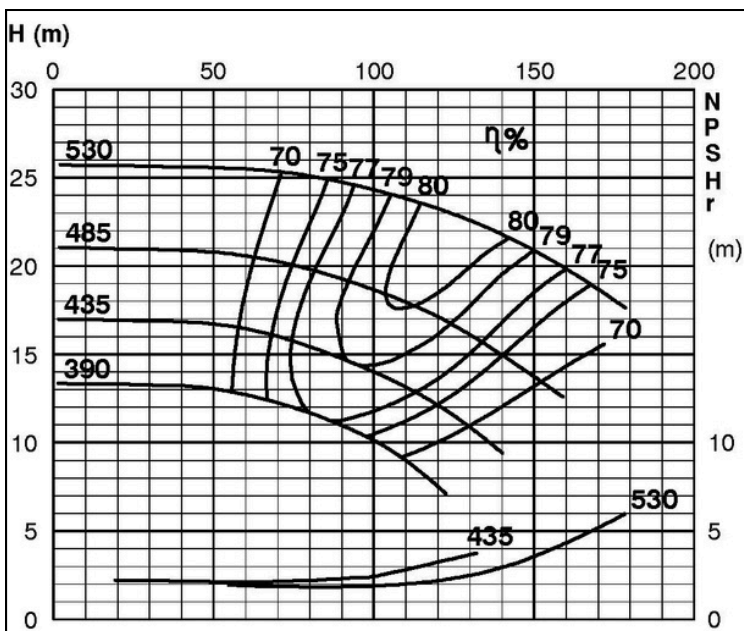

IMPELLER DIA	
∅d <sub>2</sub> (mm)	∅d <sub>b</sub> (mm)
530	465
525	462
520	459
515	456
510	452
505	449
500	446
495	443
490	440
485	438
480	435
475	432
470	429
465	427
460	424
455	421
450	418
445	416
440	414
435	412
430	410
425	408
420	406
415	404
410	402
405	400
400	398
395	395
390	390

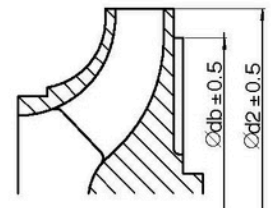
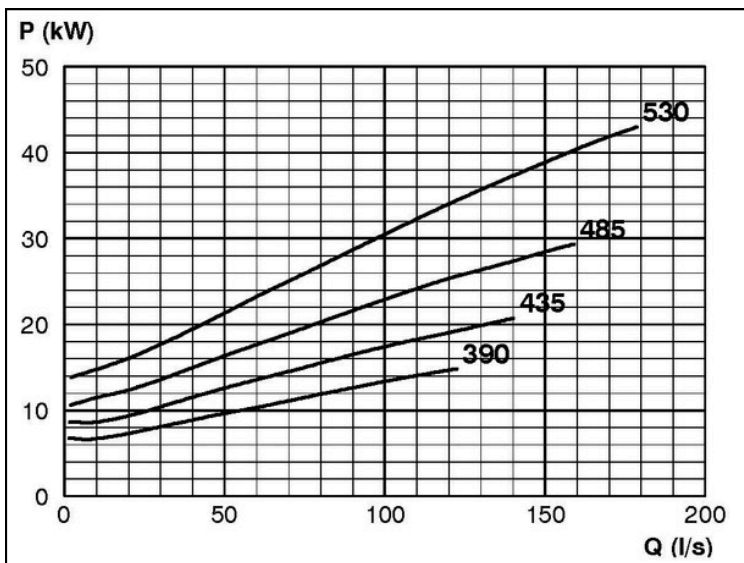

RET14157

## TECHNICAL SPECIFICATIONS



ISP Process Pumps - ISP200-500 (250-200-500)  
ISP Impeller 283933 CLOSED B49 Z6

### Performance Curve - ISP250-500-C-740

740 rpm

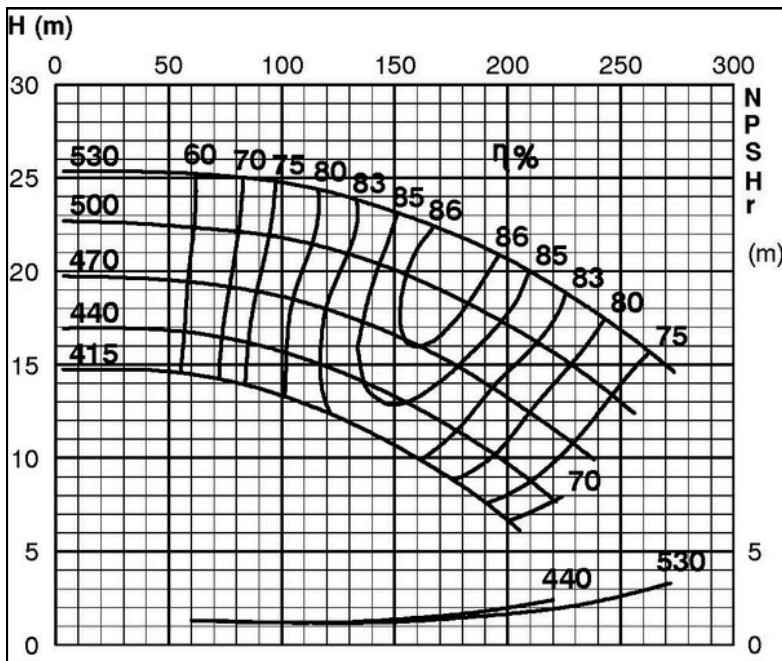

IMPELLER DIA	
∅d <sub>2</sub> (mm)	∅d <sub>b</sub> (mm)
530	492
525	491
520	489
515	487
510	485
505	481
500	476
495	472
490	467
485	465
480	462
475	459
470	456
465	452
460	448
455	445
450	441
445	439
440	436
435	433
430	430
425	425
420	420
415	415

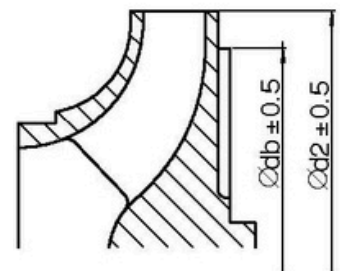
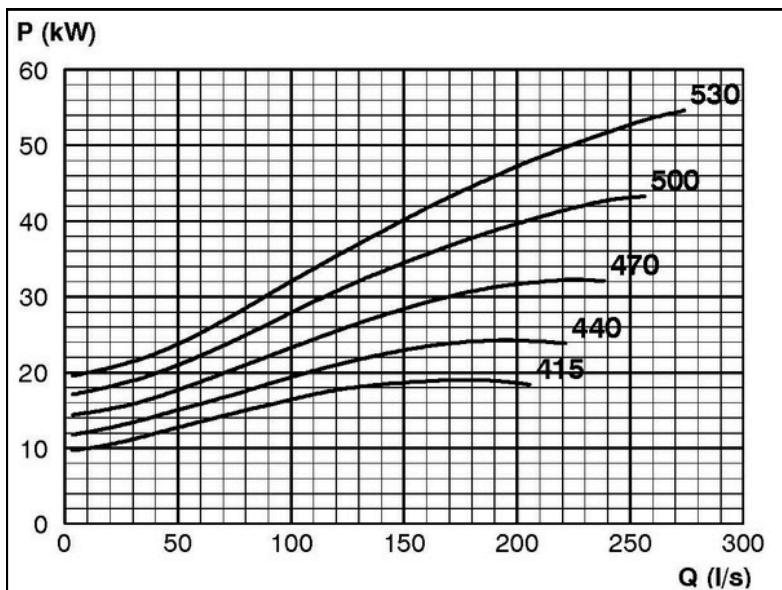

RET14158

## TECHNICAL SPECIFICATIONS



### ISP Process Pumps - ISP300-500 (350-300-500) ISP Impeller 283934 CLOSED B49 Z6

#### Performance Curve - ISP300-500-C-740

740 rpm

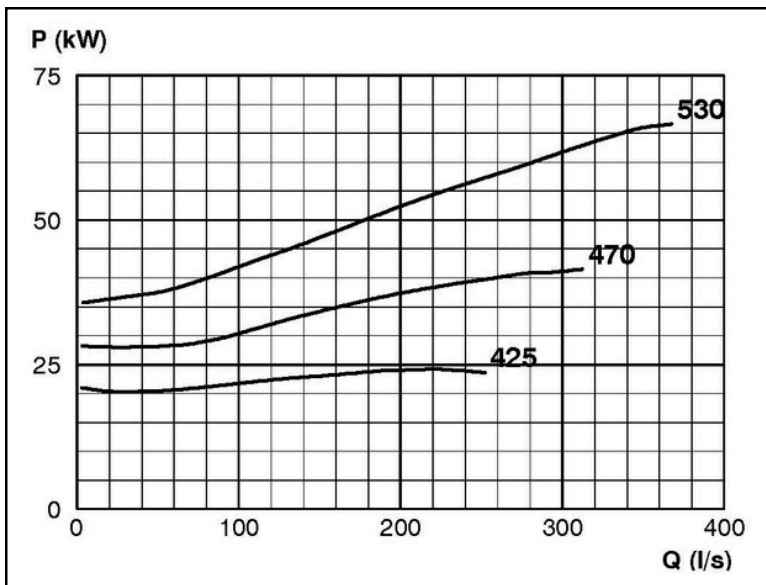
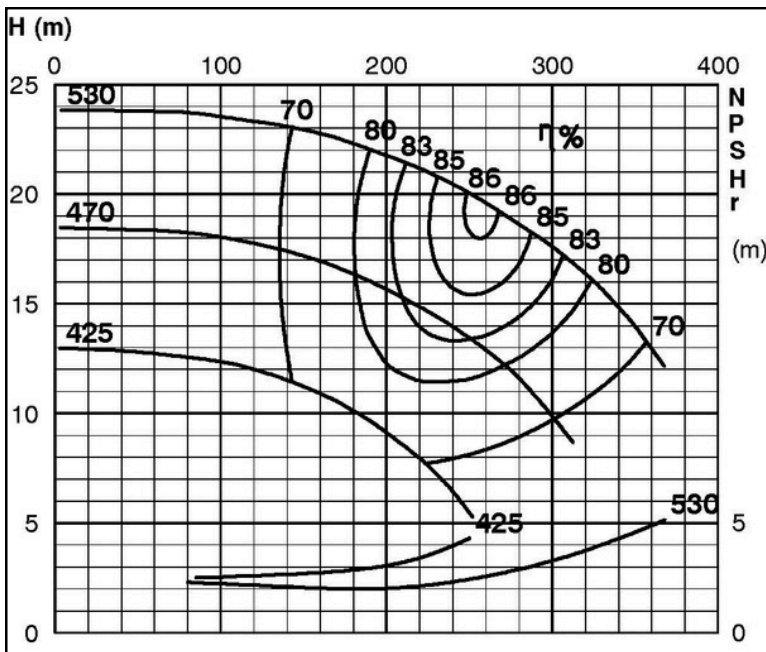

IMPELLER DIA			
$\varnothing d_2$ (mm)	K°	$\varnothing d_a$ (mm)	$\varnothing d_b$ (mm)
530			522
525			519
520			516
515			513
510			
505			
500			
495			
490			
485			
480			
475			
470			
465	1	463.0	
460	2	455.0	
455	3	448.0	
450	4	440.0	
445	5	432.0	
440	6	425.0	
435	7	417.0	
430	8	409.0	
425	10	399.0	

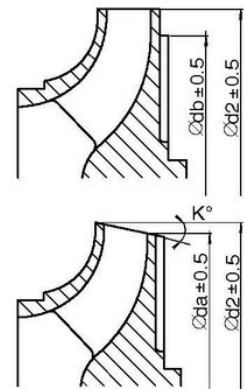

RET14159

## TECHNICAL SPECIFICATIONS



### ISP Process Pumps - ISP400-600 (500-400-600) ISP Impeller 283935 CLOSED B93 Z6

#### Performance Curve - ISP400-600-C-740

740 rpm

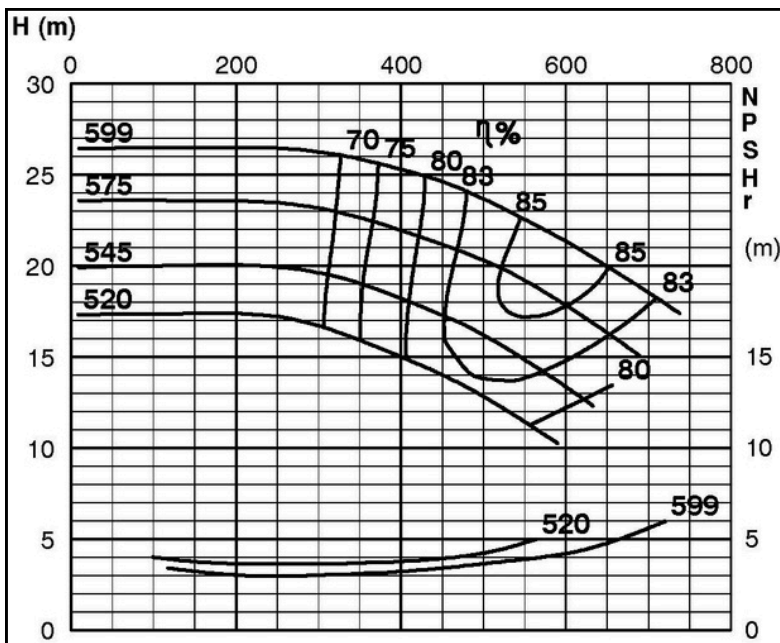

IMPELLER DIA			
Ød <sub>2</sub> (mm)	K°	Ød <sub>a</sub> (mm)	Ød <sub>b</sub> (mm)
599	7	576.5	572.6
595	7	572.0	
590	8	564.0	
585	8	559.0	
580	9	550.0	
575	9	545.0	
570	10	537.0	
565	10	531.0	
560	11	523.0	
555	11	517.0	
550	13	505.0	
545	13	500.0	
540	14	491.0	
535	14	485.0	
530	15	477.0	
525	16	468.0	
520	17	459.0	

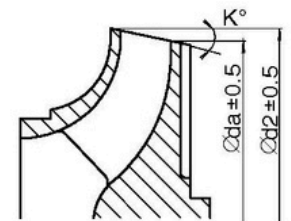
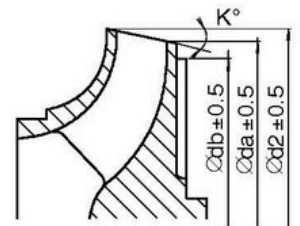
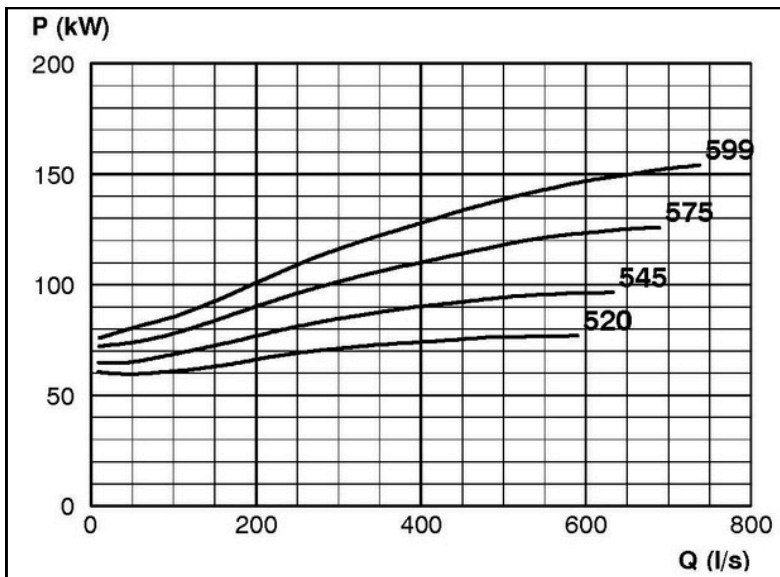

RET14160

## TECHNICAL SPECIFICATIONS



### ISP Process Pumps - ISP500-600 (500-500-600) ISP Impeller 283936 CLOSED B114 Z6

#### Performance Curve - ISP500-600-C-740

740 rpm

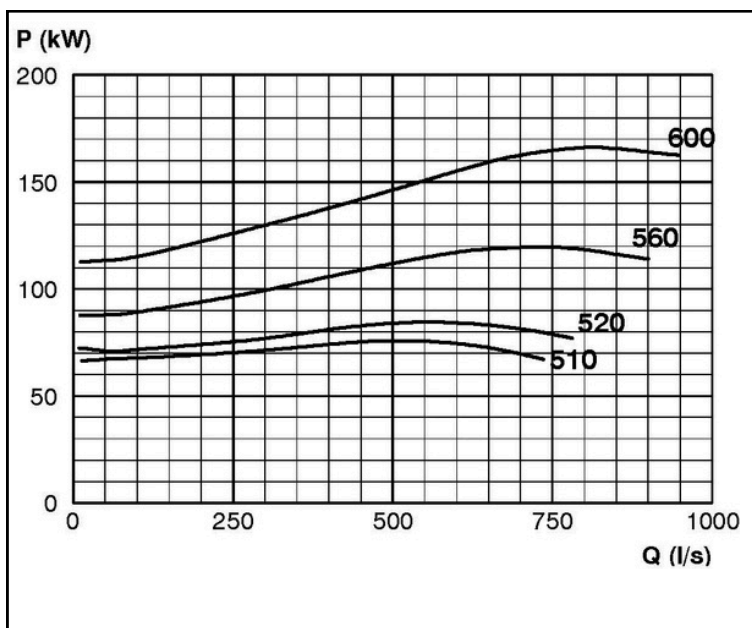
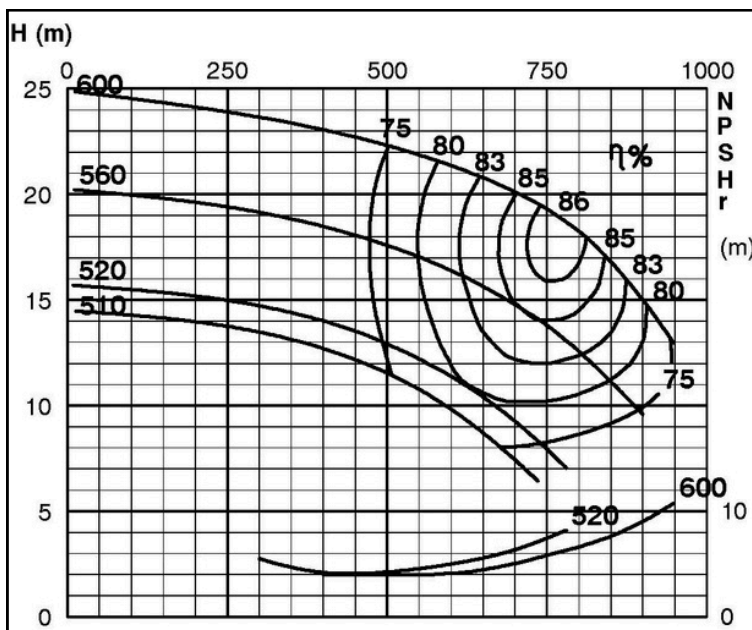

IMPELLER DIA			
Ød <sub>2</sub> (mm)	K°	Ød <sub>a</sub> (mm)	Ød <sub>b</sub> (mm)
600	15	541,2	532.7
595	15	536	532.7
590	15	530	
585	15	525	
580	15	519	
575	16	510	
570	16	504	
565	16	498	
560	17	489	
555	17	483	
550	18	478	
545	18	467	
540	19	457	
535	19	451	
530	20	440	
525	20	434	
520	21	423	
515	22	413	
510	23	400	

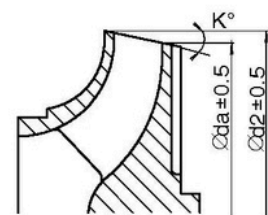
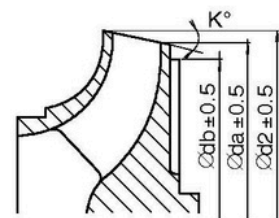

RET14161

## TECHNICAL SPECIFICATIONS



ISP Process Pumps - ISP100-600 (200-100-600)  
ISP Impeller 288288 CLOSED B30 Z5

### Performance Curve - ISP100-600-C-740

740 rpm

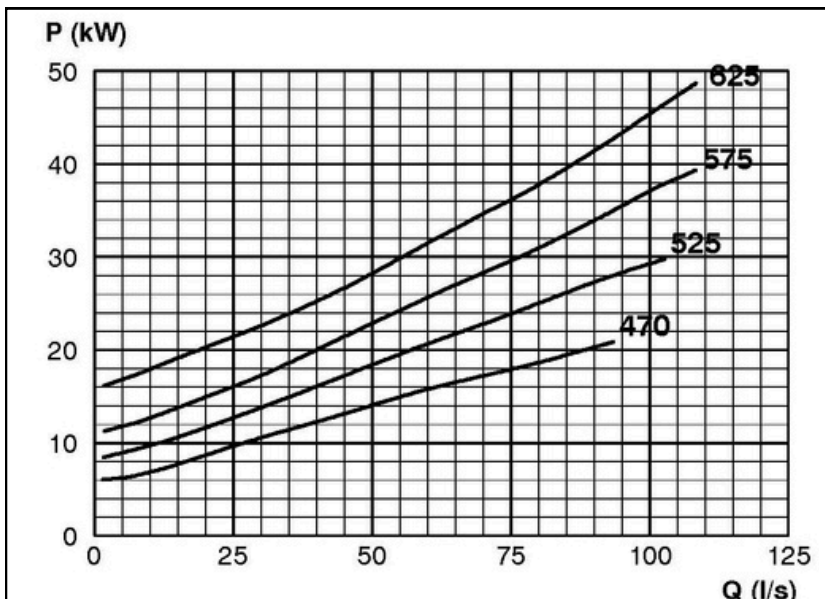
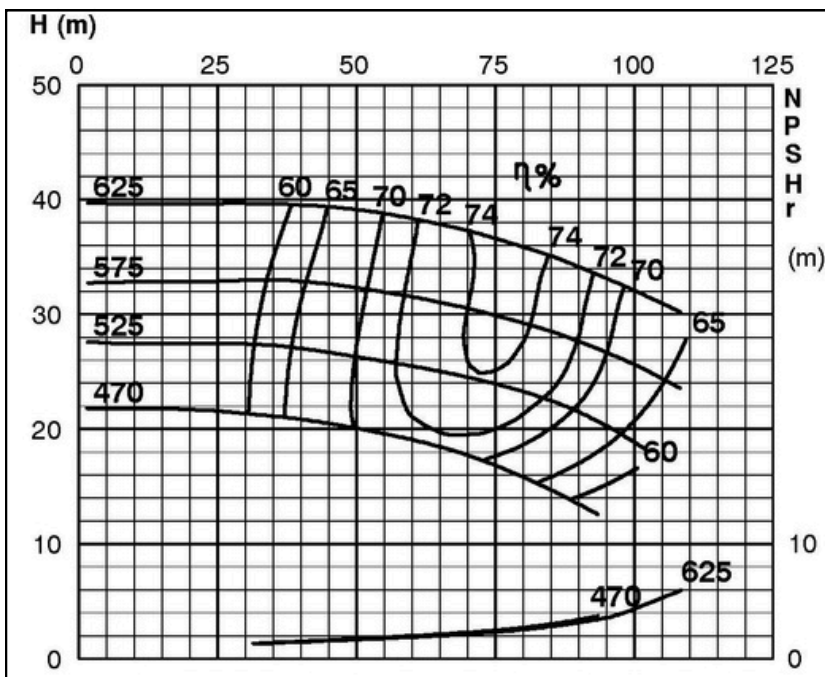

IMPELLER DIA	
∅d <sub>2</sub> (mm)	∅d <sub>b</sub> (mm)
625	420
620	417
615	415
610	412
605	410
600	407
595	405
590	402
585	400
580	397
575	395
570	392
565	390
560	387
555	385
550	382
545	380
540	377
535	373
530	370
525	367
520	365
515	362
510	360
505	357
500	355
495	352
490	350
485	347
480	345
475	342
470	340

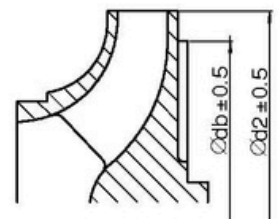

RET14162

## TECHNICAL SPECIFICATIONS



### ISP Process Pumps - ISP200-600 (300-200-600) ISP Impeller 284004 CLOSED B35 Z6

#### Performance Curve - ISP200-600-C-740

740 rpm

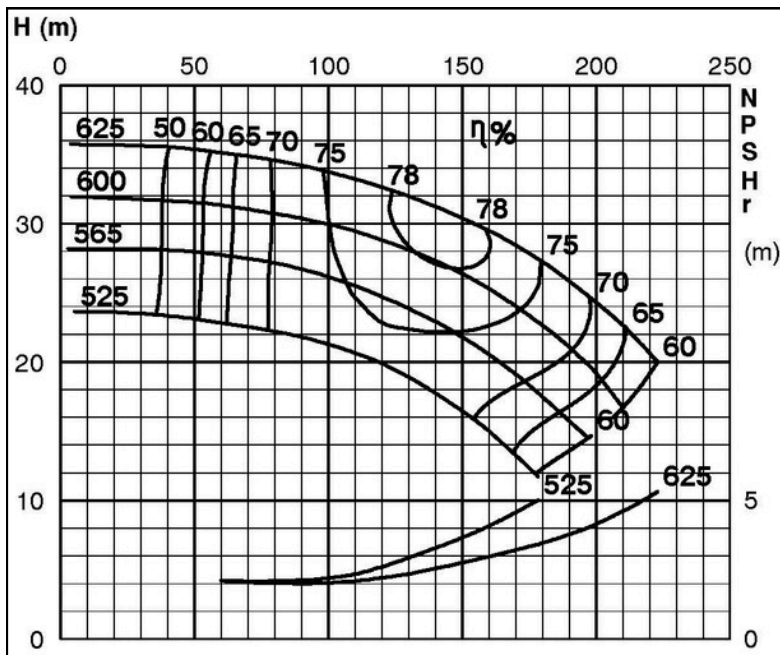

IMPELLER DIA	
∅d <sub>2</sub> (mm)	∅d <sub>b</sub> (mm)
625	539
620	538
615	533
610	529
605	525
600	522
595	519
590	517
585	514
580	512
575	509
570	505
565	504
560	503
555	500
550	499
545	497
540	495
535	492
530	488
525	485

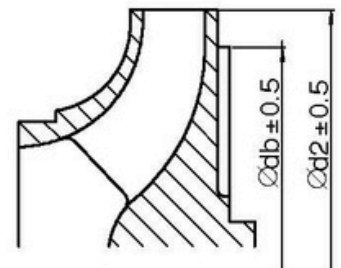
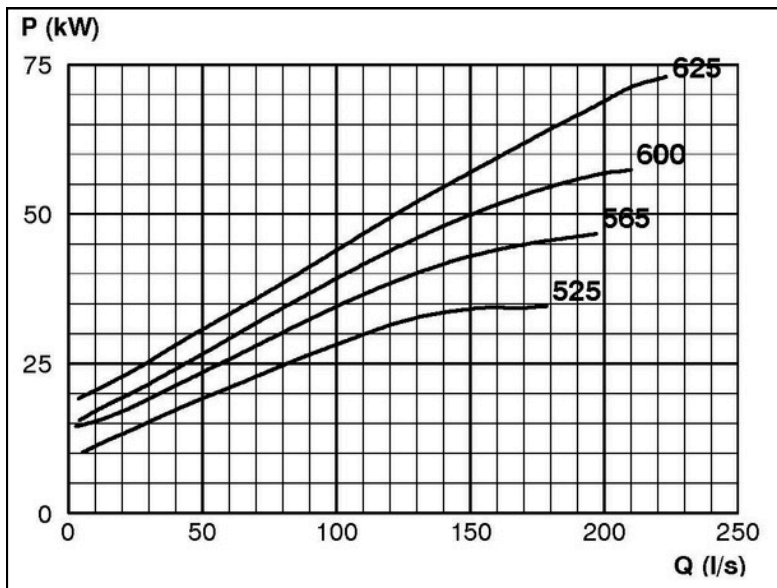

RET14163

## TECHNICAL SPECIFICATIONS



### ISP Process Pumps - ISP250-600 (300-250-600) ISP Impeller 284005 CLOSED B43 Z6

#### Performance Curve - ISP250-600-C-740

740 rpm

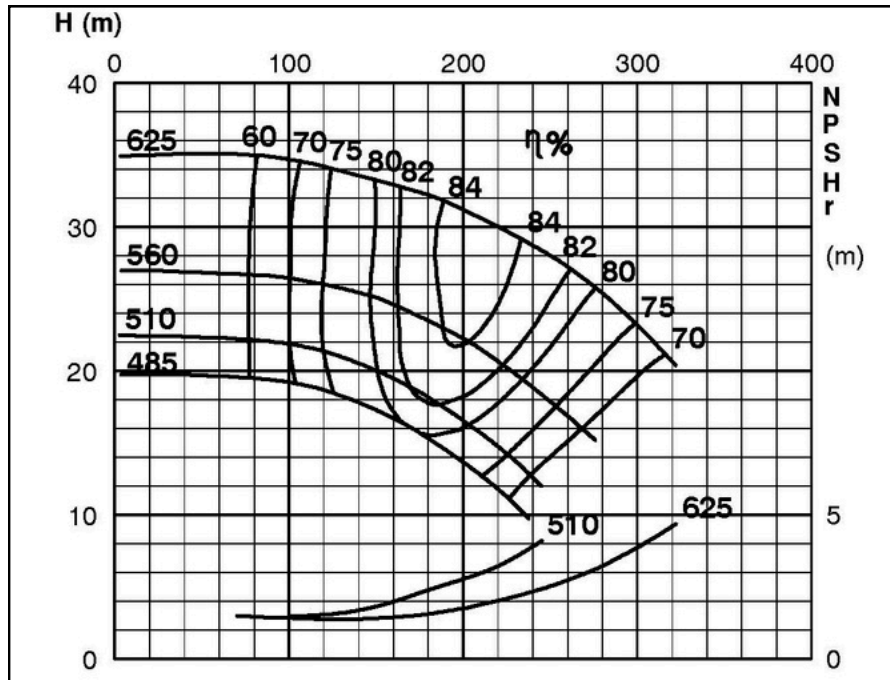

IMPELLER DIA	
∅d <sub>2</sub> (mm)	∅d <sub>b</sub> (mm)
625	555
620	553
615	550
610	546
605	543
600	542
595	539
590	537
585	534
580	529
575	528
570	525
565	521
560	518
555	516
550	514
545	513
540	512
535	510
530	507
525	504
520	503
515	502
510	497
505	496
500	494
495	493
490	490
485	485

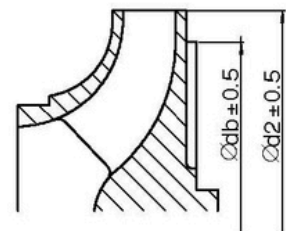
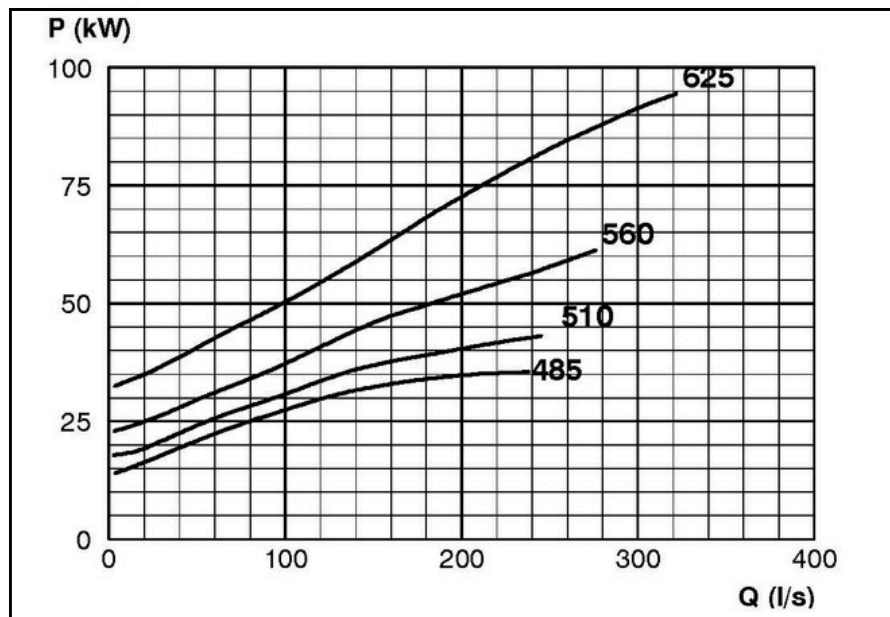

RET14164

## TECHNICAL SPECIFICATIONS



### ISP Process Pumps - ISP300-600 (400-300-600) ISP Impeller 284006 CLOSED B61 Z6

#### Performance Curve - ISP300-600-C-740

740 rpm

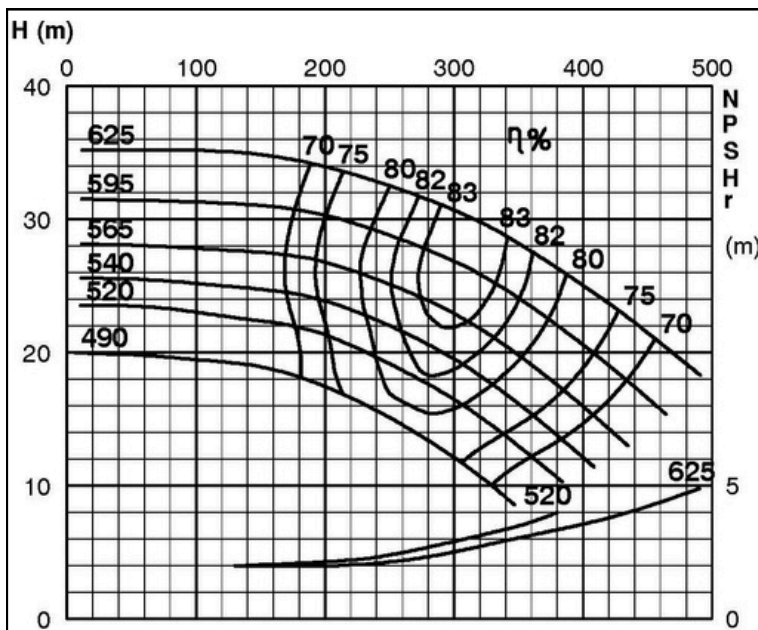

IMPELLER DIA			
∅d <sub>2</sub> (mm)	K°	∅d <sub>a</sub> (mm)	∅d <sub>b</sub> (mm)
625			609
620			603
615			598
610			594
605			591
600			587
595			584
590			581
585			576
580			572
575			569
570			566
565			561
560			558
555			555
550			550
545			545
540			540
535			535
530			530
525	1	524	
520	2	515	
515	3	510	
510	4	502	
505	4.5	496	
500	5	489	
495	5.5	483	
490	6	477	

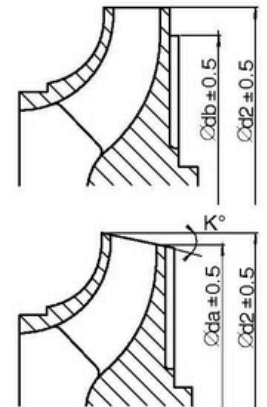
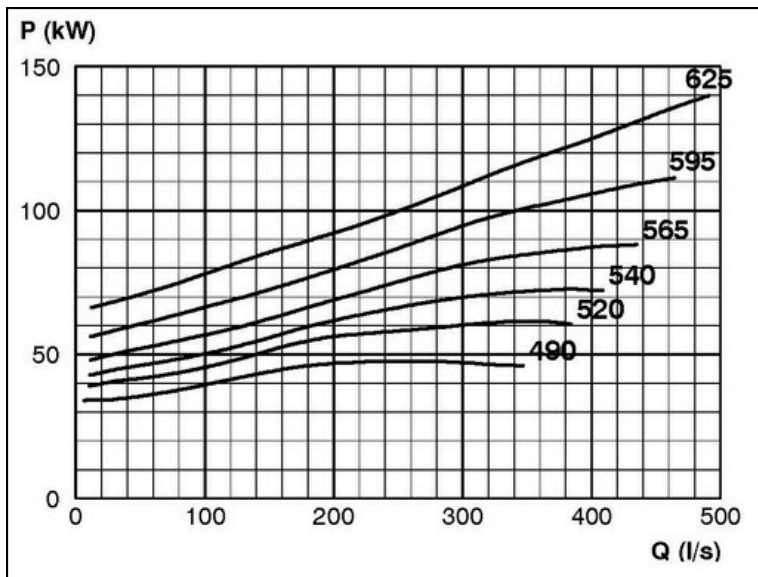

RET14165