

### TECHNICAL SPECIFICATIONS



#### ISP Process Pumps - ISP150-400 (200-150-400)

#### ISP Impeller 283890 Open B26 Z5

ISRP: Impeller 285271 OPEN B26 Z5, Please add the power demand of the degassing unit = 0.7 kW

ISSP: Impeller 285271 OPEN B26 Z5, Please add the power demand of the degassing unit = 1.5 kW

#### Performance Curve - ISP150-400-O-980

980 rpm

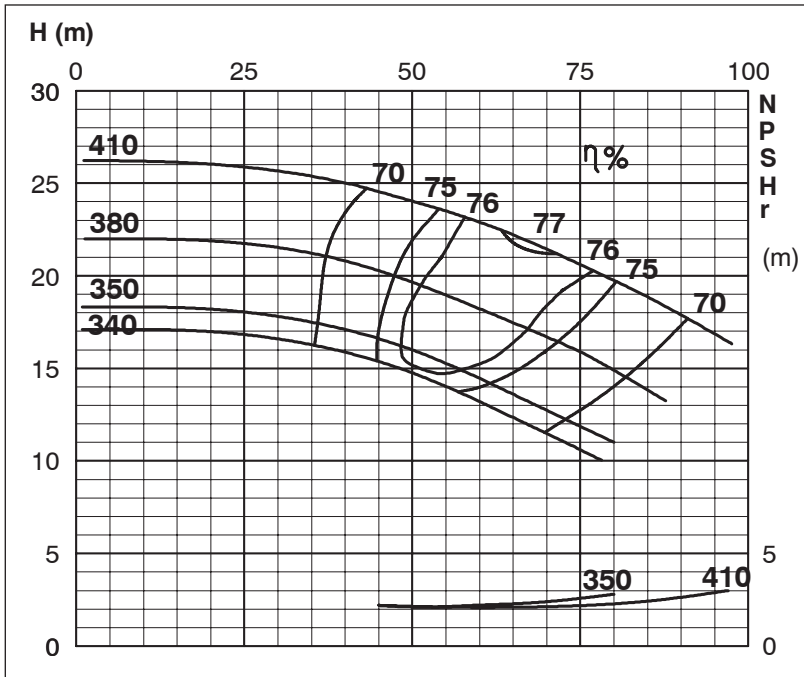

Impeller Dia		
Ød <sub>2</sub> (mm)	K°	Øda (mm)
410		
405		
400		
395		
390		
385		
380	1	379
375	2	373
370	3	367
365	4	361
360	5	355
355	6	349
350	7	343
345	7	338
340	8	332

