

TECHNICAL SPECIFICATIONS



ISP Process Pumps - ISP32-250 (50-32-250)

ISP Impeller 288449 Open B7 Z3

ISRP: Impeller289016OPENB7Z3, Please add the power demand of the degassing unit = 0.3kW

ISSP: Impeller289016OPENB7Z3, Please add the power demand of the degassing unit = 1.0kW

Performance Curve - ISP32-250-O-920

920 rpm

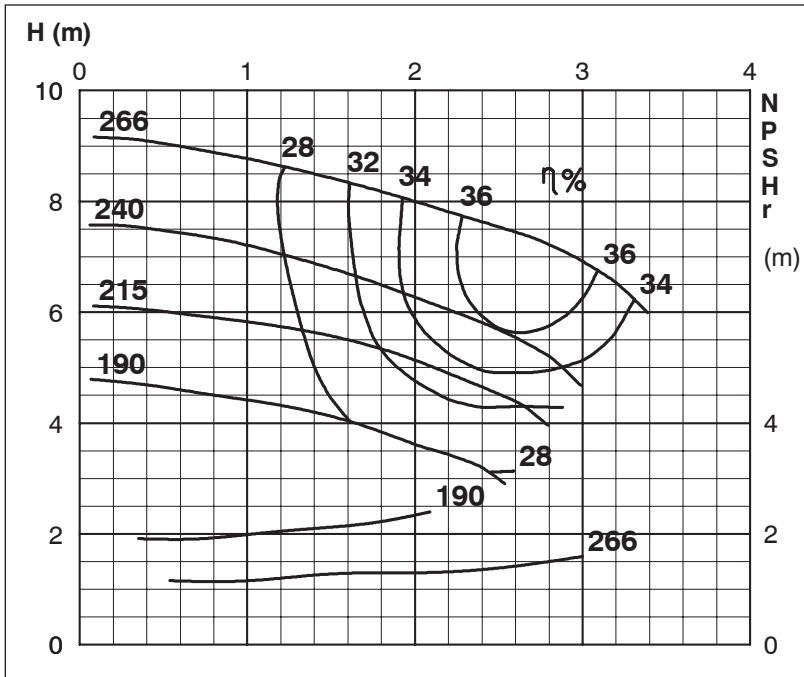

Impeller Dia
Ød ₂ (mm)
266
260
255
250
245
240
235
230
225
220
215
210
205
200
195
190
185
180
175
170
165

