

TECHNICAL SPECIFICATIONS



ISP Process Pumps - ISP40-200 (65-40-200)

ISP Impeller 283868 Open B12 Z3

ISRP: Impeller 287959 OPEN B12 Z3, Please add the power demand of the degassing unit = 0.5 kW

ISSP: Impeller 287959 OPEN B12 Z3, Please add the power demand of the degassing unit = 0.7 kW

Performance Curve - ISP40-200-O-1410

1410 rpm

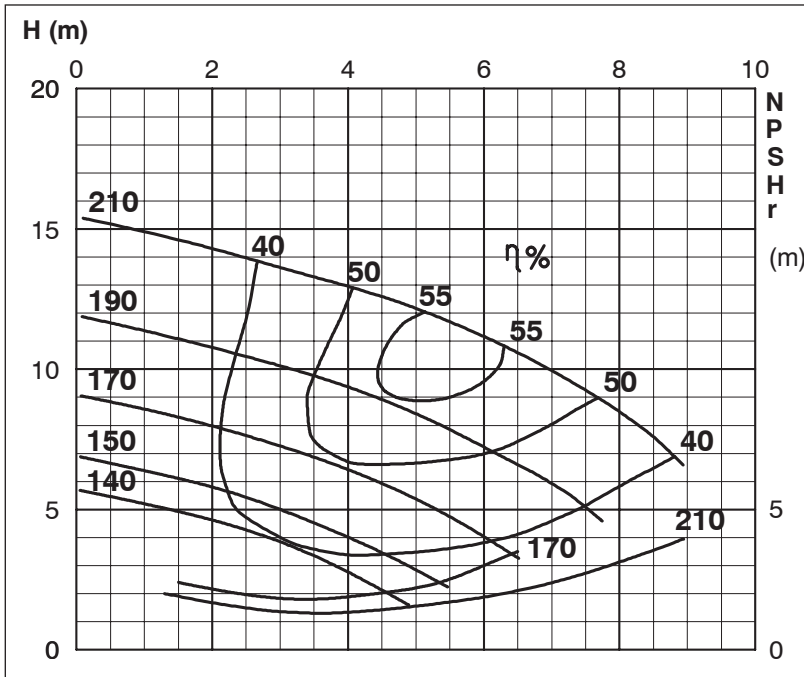

Impeller Dia
Ød ₂ (mm)
210
205
200
195
190
185
180
175
170
165
160
155
150
145
140

