

TECHNICAL SPECIFICATIONS



ISP Process Pumps - ISP40-250 (65-40-250)

ISP Impeller 287015 Open B10 Z3

ISRP: Impeller 287963 OPEN B10Z3, Please add the power demand of the degassing unit = 0.3kW

ISSP: Impeller 287963 OPEN B10Z3, Please add the power demand of the degassing unit = 1.0kW

Performance Curve - ISP40-250-O-910

910 rpm

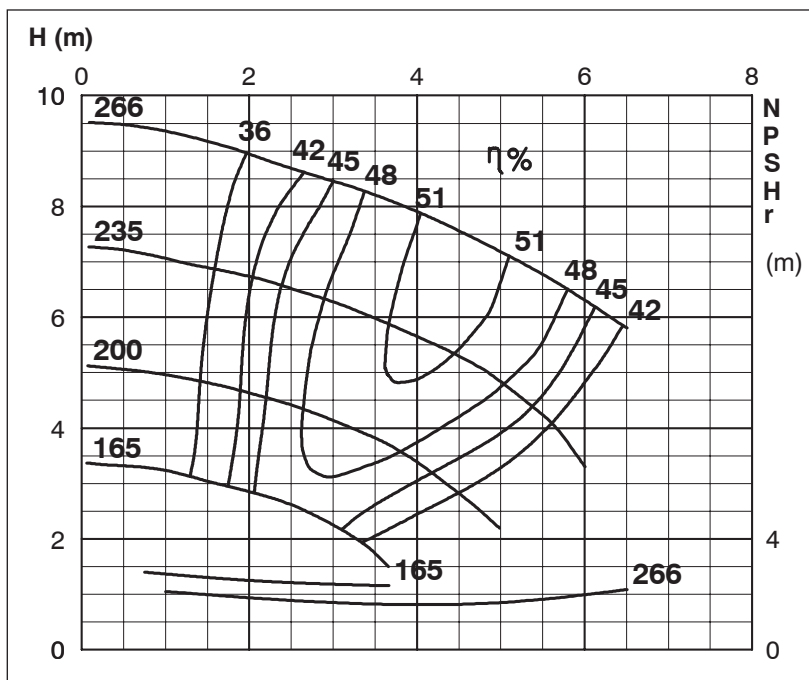

Impeller Dia
Ød ₂ (mm)
266
260
255
250
245
240
235
230
225
220
215
210
205
200
195
190
185
180
175
170
165

