

TECHNICAL SPECIFICATIONS



ISP Process Pumps - ISP50-250 (80-50-250)

ISP Impeller 283872 Open B14 Z3

ISRP: Impeller 287964 OPEN B14 Z3, Please add the power demand of the degassing unit = 0.9 kW

ISSP: Impeller 287964 OPEN B14 Z3, Please add the power demand of the degassing unit = 1.2 kW

Performance Curve - ISP50-250-O-1440

1440 rpm

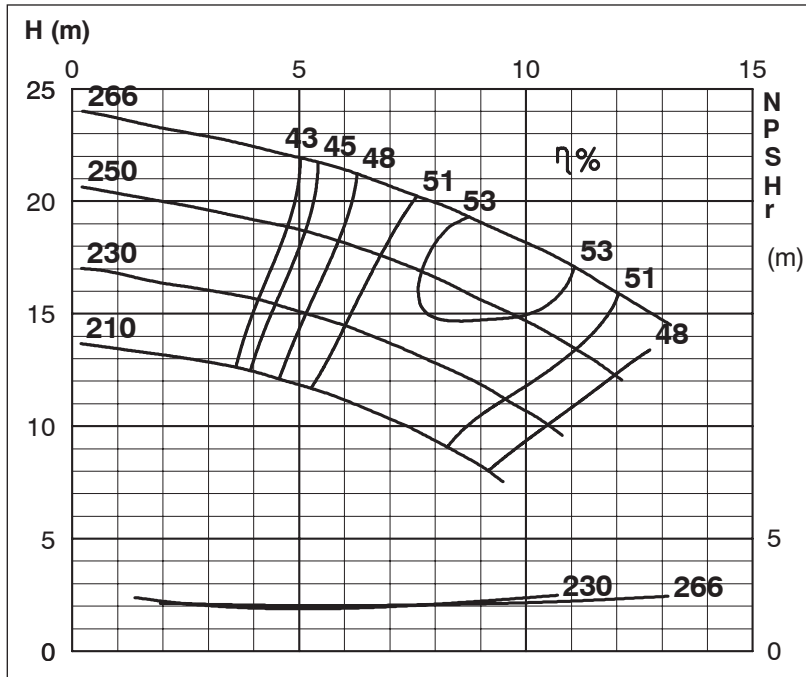

Impeller Dia
Ød ₂ (mm)
266
260
255
250
245
240
235
230
225
220
215
210

