

### TECHNICAL SPECIFICATIONS



#### ISP Process Pumps - ISP50-250 (80-50-250)

#### ISP Impeller 283872 Open B14 Z3

ISRP: Impeller 287964 OPEN B14 Z3, Please add the power demand of the degassing unit = 7.1 kW

ISSP: Impeller 287964 OPEN B14 Z3, Please add the power demand of the degassing unit = 2.5 kW

#### Performance Curve - ISP50-250-O-2940

2940 rpm

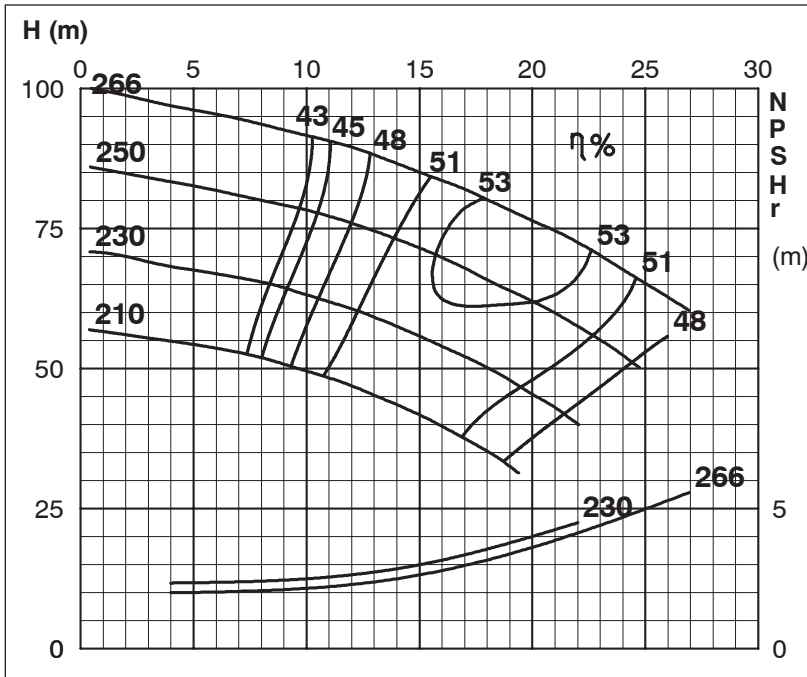

Impeller Dia
Ød <sub>2</sub> (mm)
266
260
255
250
245
240
235
230
225
220
215
210

