

TECHNICAL SPECIFICATIONS



ISP Process Pumps - ISP65-250 (100-65-250)

ISP Impeller 283873 Open B18 Z3

ISRP: Impeller 287965 OPEN B18 Z3, Please add the power demand of the degassing unit = 0.9 kW

ISSP: Impeller 287965 OPEN B18 Z3, Please add the power demand of the degassing unit = 1.2 kW

Performance Curve - ISP65-250-O-1440

1440 rpm

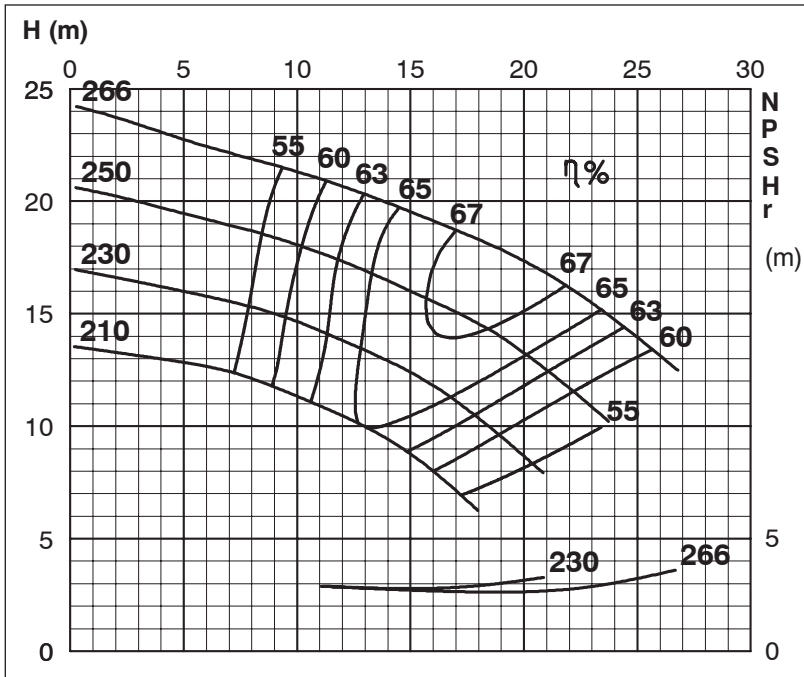

Impeller Dia
Ød ₂ (mm)
266
260
255
250
245
240
235
230
225
220
215
210

