

TECHNICAL SPECIFICATIONS



ISP Process Pumps - ISP80-250 (125-80-250)

ISP Impeller 283874 Open B24 Z4

ISRP: Impeller 287966O PEN B24Z4, Please add the power demand of the degassing unit = 0.3kW

ISSP: Impeller 287966 OPEN B24Z4, Please add the power demand of the degassing unit = 1.0kW

Performance Curve - ISP80-250-O-960

960 rpm

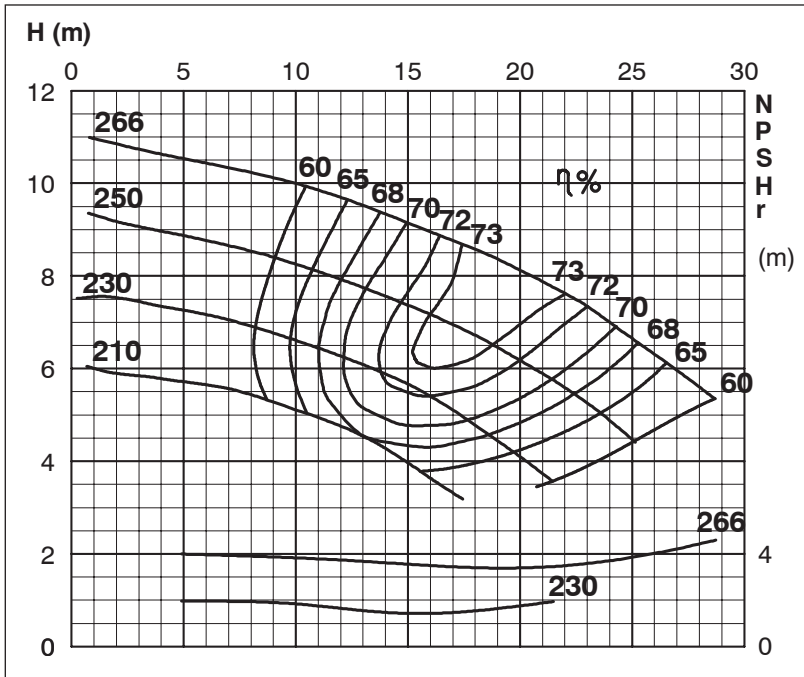

Impeller Dia
Ød ₂ (mm)
266
260
255
250
245
240
235
230
225
220
215
210

